

**Agilent PN 4395-1**

**Agilent 4395A Network/Spectrum/  
Impedance Analyzer**

**ADSL Copper Loop Measurements**

Product Note



**Agilent Technologies**

Innovating the HP Way

## Introduction

ADSL (Asymmetric Digital Subscriber Line) is an enabling technology for high data rate communication and fast internet access over ordinary telephone lines. ADSL modems can transfer data at up to 8 Mbps for downstream and 640 kbps for upstream. Future extensions, such as VDSL, will increase this rate to 52 Mbps. This is many times faster than current high speed modems.

ADSL shares the copper wires with POTS (Plain Old Telephone Service) and ISDN. One important criteria for deploying ADSL service is to ensure that there's no interference to these existing services.

Since the copper infrastructure was not designed for high frequency use, measuring the physical layer of the loop is required to ensure successful deployment of ADSL services. Because one end of the loop is in the central office (CO) and the other end is on the subscriber premises, only one end of the loop is typically available for testing.

This document is a brief guide for making loop measurements. Since the loop is a balanced cable, there are several things that should be taken into account for better measurements.

## Balanced & Unbalanced

On an unbalanced transmission line, such as coaxial cable, the outer conductor is grounded and the signal is applied to the center conductor. This is a very simple and common means of communicating. However, this method takes more space, doesn't have very high immunity for common mode noise and is more expensive to install and maintain than balanced pairs.

The balanced transmission method used for the copper loop, on the other hand, transmits equal but opposite polarity signals through parallel transmission lines. This ensures high noise immunity because external noise is applied to both transmission lines and is easily canceled. Therefore balanced transmission is commonly used for voice and data communications.

Almost all measurement instruments have unbalanced input and output ports. Thus, a device that converts balanced signals to unbalanced signals is required. This conversion device is called a BALUN (BALANCED UNbalanced) transformer.

A BALUN transformer can also convert the system impedance. The system impedance in the POTS band is 600  $\Omega$  and in the ADSL band is 100  $\Omega$ . Meanwhile, a measurement instrument like

a network analyzer typically is unbalanced and it has 50  $\Omega$  port impedance. You need to use a BALUN to match both of the system impedances. For example, a 50:100 BALUN should be chosen to measure cables in the ADSL band.

BALUN selection, measurement connections, and calibration techniques will be discussed later.

## Measurement Parameters

There are several important parameters to evaluate the characteristics of copper wires. This section will review those key parameters.

### Characteristic impedance ( $Z_c$ )

Characteristic impedance is a key evaluation parameter. There are a few ways to obtain this parameter as follows:

- Measure terminated input impedance
- Measure with open/short circuit terminations and calculate  $Z_c$
- Measure propagation constant and capacitance and calculate  $Z_c$

One of the most often used measurement methods is the open/short method. It measures the impedance of a cable terminated with an open and short at the other end, then applies the following equation:

$$Z_c = \sqrt{|Z_{OPEN}| * |Z_{SHORT}|}$$

**Attenuation**

Attenuation is an important parameter used for defining the maximum allowable cable length and the frequency response of the cable. The attenuation is defined as the forward transmission S-parameter called S21.

**Cross talk (FEXT, NEXT)**

Since several copper twisted pairs are combined in a cable, the interference between pairs is also very important to evaluate. Cross talk is the parameter used for this purpose. There are two types of cross talk parameter, Far End Cross Talk (FEXT) and Near End Cross Talk (NEXT).

**Longitudinal conversion loss (LCL)**

LCL shows how well the balanced pair rejects common mode signals. If the loop is not perfectly balanced, external noise immunity will be degraded. It might also be a source of EMC and cross talk.

**Spectrum**

When ADSL signals are transmitted, their spectrum should all be outside of the POTS and ISDN frequency ranges. If the ADSL signal is within the allowable magnitude vs. frequency limits (mask) then there will not be interference.

**Measurement setup**

This section describes the actual measurement setup for the parameters discussed in the previous section, assuming that copper wires are measured in the ADSL band.

**Characteristic impedance**

To obtain the characteristic impedance by the open/short method, the measurement is basically an S11 configuration. You need a reflection/transmission bridge and BALUN. To match the loop impedance, the BALUN should have 50 Ω unbalanced input and 100 Ω balanced output.

**Attenuation**

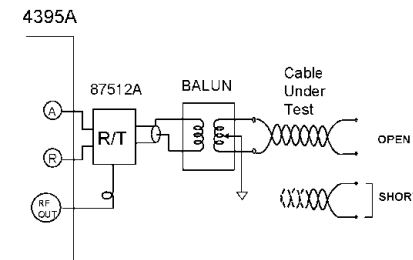

During the attenuation measurement a grounded shield should be used to isolate the two ends of the cable.

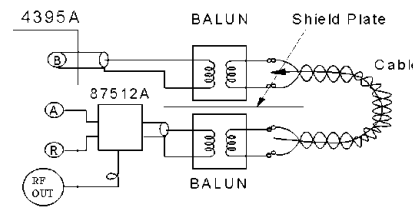

**Cross talk (NEXT)**

To measure cross talk, you need two BALUNs and two 100 Ω loads. The following figure shows the measurement configuration for NEXT. To maintain better isolation between source and receiver, putting a grounded shield plate between two BALUNs is recommended.

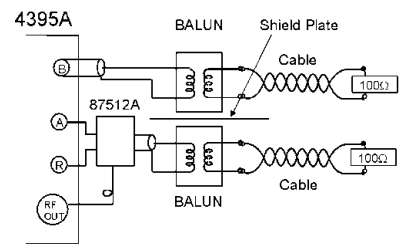

Typically FEXT is measured on installed plant, for example, when the cable is actually installed between a central office and a subscriber. Since it is impossible to connect both ends of the cable to a network analyzer, FEXT is typically not evaluated with a single test instrument.

**LCL**

LCL can be measured by using a reflection/transmission test set and BALUN. Note that the use of a 50 Ω through termination brings the common mode impedance to 1/4 of the balanced impedance.

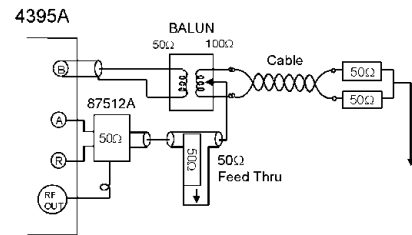

### Spectrum

The input port needs to be converted from balanced mode to unbalanced spectrum measurement mode by using a BALUN as shown in the figure below.

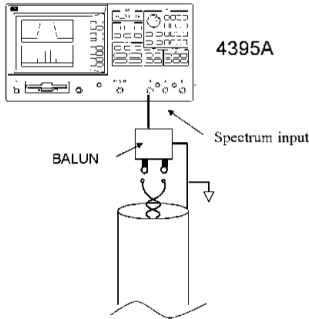

### Calibration

To make the above measurements, the following calibration is required before actual measurement. This section describes how to perform necessary calibrations, assuming the cable is measured in ADSL band (100 Ω).

Meas. Parameter	Calibration
Characteristic Impedance	S11 1-port cal.
Attenuation	Response & Isolation
Cross Talk	Response & Isolation
LCL	Response & Isolation
Spectrum	Level calibration

You have to input 100 Ω into  $Z_o$  of the Agilent 4395A before performing network measurement calibrations.

### S11 1-port calibration

To remove the frequency response, source match, and directivity, a 1-port calibration must be performed at the balanced end of the BALUN. To perform the 1-port calibration, you have to prepare short and 100 Ω LOAD standards. (open condition can be made by connecting nothing.)

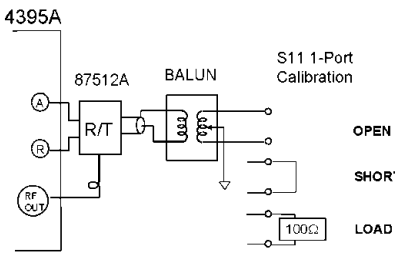

### Response and isolation for cross talk and attenuation

To make response (thru) configuration, you should connect the balanced BALUN ports to each other.

For the Isolation calibration, you should terminate each balanced port of the BALUNs with a 100 Ω load.

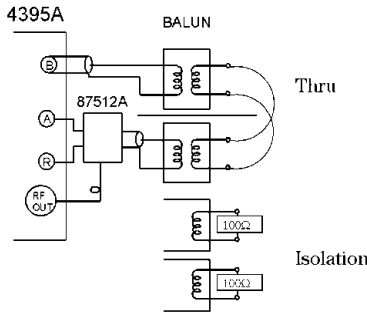

### Response and isolation for LCL

In Response and Isolation calibration for LCL, the setup configuration for calibration is different from that for Crosstalk.

The following figure shows the setup configuration of thru calibration for LCL.

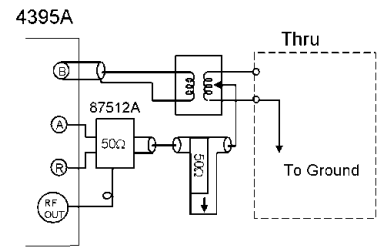

The following figure shows the setup configuration of Isolation calibration for LCL.

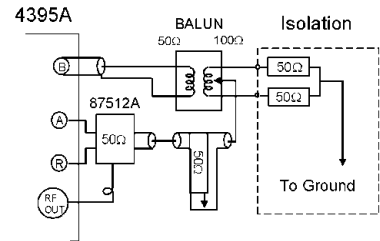

Since the impedance matching at the far end is very critical for LCL measurement, you have to choose the terminating resistance carefully. To ensure a good LCL measurement, the termination used here should have precise resistance value over the frequency range of interest. The recommended accuracy for the resistance is 0.01%.

## Spectrum

Before making spectrum measurements, the signal loss caused by the BALUN should be calibrated with a BALUN and an external signal generator. You need to shunt the input of the BALUN with a 100  $\Omega$  resistor so that the output impedance from an external signal generator is 50  $\Omega$ . If the system impedance of the cable to be tested is 600  $\Omega$ , the shunt impedance should be 54.5  $\Omega$ . This calibration data should be subtracted from actual measurement data with the DATA-MEM function.

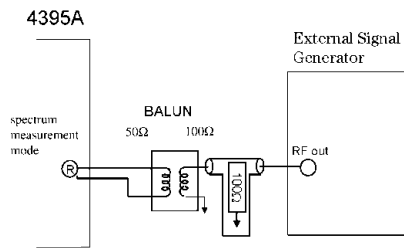

## Miscellaneous Considerations

### Measurement instrument selection

For ADSL, the operation frequency is from 20 kHz to 1.1 MHz. Thus, the measurement instrument needs to cover the lower frequency. In addition, coverage of the POTS frequency (30 Hz to 3 kHz) is preferable.

- Frequency: 30 Hz to 1.1 MHz
- High Frequency Resolution(1 mHz)
- Wider dynamic range and lower system noise floor for lower frequency area.
- Narrower RBW and IFBW for lower frequency measurement.

## BALUN selection

The BALUN should cover the frequency range of interest and also needs to have impedance matching between the analyzer and cable.

The BALUN should have flat impedance characteristics over the required frequency range. That is, the variation in insertion loss over the frequency range should not exceed 3 dB. The open impedance of the BALUN should be greater than ten times the system impedance especially for lower frequencies. This is because the BALUN is made using an inductor whose impedance gets lower as the frequency is decreased. The open value should be more than ten times the system impedance. Low insertion loss and high return loss plus a CMRR > 50 dB are desirable so that the BALUN does not become part of the measurement.

You need to select BALUNs in accordance to the system impedance of the cable to be tested. This application note provides measurement examples for the ADSL frequency band. When measuring in the POTS band, you need to use a 50:600 (or 900) BALUN, or a 50:736 BALUN because the IEEE 455 standard calls for a terminating impedance of 736  $\Omega$  (the geometric mean of these two) as a standard system impedance for POTS measurements.

## Long cable measurement

The open/short method assumes that the cable has consistent characteristics over the whole length of the cable. If possible, the length of the cable should be less than  $\lambda/10$  of the measurement frequency and/or a time delay needs to be used so that the reference and test channels are both measuring the same signal. (See Reference 2 on Page 6.)

## Recommended Equipment

- Agilent 4395A 10 Hz-500 MHz Network/Spectrum/Impedance Analyzer
- Agilent 87512A DC-2 GHz Transmission/Reflection Test Set
- Agilent 11048C 50  $\Omega$  Feedthrough

North Hills Signal Processing provides BALUNs that cover from 20 Hz to 6 MHz.

North Hills Signal Processing  
A Porta System Company  
575 Underhill Boulevard,  
Syosset, NY 11791, USA  
Tel: +1-516-682-7740  
Fax: +1-516-682-7704  
E-mail: info@northhills-sp.com

## References

1. *8 Hints for Network Analysis*  
<http://literature.agilent.com/litweb/pdf/5965-8166E.pdf>
2. *DSL Forum*  
[www.adsl.com/](http://www.adsl.com/) -
3. *T 1.413 Specification*  
[http://web.ansi.org/default\\_js.htm](http://web.ansi.org/default_js.htm)  
*IEEE 455 Standard*  
[www.ieee.org/](http://www.ieee.org/)  
*ASTM D-4566 Standard*  
<http://www.astm.org/>

## Agilent Technologies' Test and Measurement Support, Services, and Assistance

Agilent Technologies aims to maximize the value you receive, while minimizing your risk and problems. We strive to ensure that you get the test and measurement capabilities you paid for and obtain the support you need. Our extensive support resources and services can help you choose the right Agilent products for your applications and apply them successfully. Every instrument and system we sell has a global warranty. Support is available for at least five years beyond the production life of the product. Two concepts underlie Agilent's overall support policy: "Our Promise" and "Your Advantage."

### Our Promise

"Our Promise" means your Agilent test and measurement equipment will meet its advertised performance and functionality. When you are choosing new equipment, we will help you with product information, including realistic performance specifications and practical recommendations from experienced test engineers. When you use Agilent equipment, we can verify that it works properly, help with product operation, and provide basic measurement assistance for the use of specified capabilities, at no extra cost upon request. Many self-help tools are available.

### Your Advantage

"Your Advantage" means that Agilent offers a wide range of additional expert test and measurement services, which you can purchase according to your unique technical and business needs. Solve problems efficiently and gain a competitive edge by contracting with us for calibration, extra-cost upgrades, out-of-warranty repairs, and on-site education and training, as well as design, system integration, project management, and other professional services. Experienced Agilent engineers and technicians worldwide can help you maximize your productivity, optimize the return on investment of your Agilent instruments and systems, and obtain dependable measurement accuracy for the life of those products.

**Get assistance with all your test and measurement needs at:**  
[www.agilent.com/find/assist](http://www.agilent.com/find/assist)

Product specifications and descriptions in this document subject to change without notice.

Copyright © 1999, 2000 Agilent Technologies  
Printed in U.S.A. 11/00  
5968-1196E



**Agilent Technologies**

Innovating the HP Way